

TSSU-72-08-HC

 Prep Table, 8x 1/6 Top Pans, 3 Solid Swing Doors



Dimensions		Build		Technical	
External Width (mm)	1839	Door Description	3 Solid Swing Doors	Temperature Holding	0.5 : 5°C
External Depth (mm)	766	Exterior Construction	Stainless steel front, top & hood, aluminium sides and rear	Refrigerant	R290
External Height (mm)	1093	Interior Construction	Clear coated aluminium, stainless steel base	Voltage / Frequency / Phase	220-240V/50Hz/1
Exclusions	Depth does not include 26 mm for rear bumpers. Height with lid closed.	Air Intake Position	Front	Amps	3.1
Gross Volume (Litres)	538	Ventilation Position	Front	60Hz model Amps	3.1
Supplied Shelves	6	Clearance Required	Zero back and sides	Wattage	713
Shelf Size (L x D mm)	Left & Right Upper: 547 x 514. Central Upper: 596 x 539. Left & Right Lower: 547 x 349. Central Lower: 596 x 349	Cord Length (Meters)	3.35	60Hz model Wattage	713
Internal Net Height (mm)	535	Standard w/ Locks	Not standard (SPEC3 option)	Defrost Type	Auto
Top Pans Supplied (max depth mm)	8x 1/6 GN (100)				
Unpackaged Weight (kg)	187				
Packaged Weight (kg)	198				
Packaged Dimensions (W x D x H mm)	1931 x 839 x 1270				
Cutting Board (L x D mm)	1893 x 299				
Supplied Supports	∅ 127 mm castors (158 mm height)				



Specifications subject to change without notice.
 Technical data above related to energy use based on testing of 50Hz or Dual Frequency models
 Chart dimensions rounded up to the next whole millimeter (inches rounded up to the 1/8")

UK & Ireland [0800 783 2049](tel:08007832049)
 EMEA [+41 61 563 07 05](tel:+41615630705)
 Australia [+61 2 9619 9999](tel:+61296199999)

TFIUK@truemfg.com
TrueCHCustomerService@truemfg.com
TrueRefAus@truemfg.com



TSSU-72-08-HC

Prep Table, 8x 1/6 Top Pans, 3 Solid Swing Doors

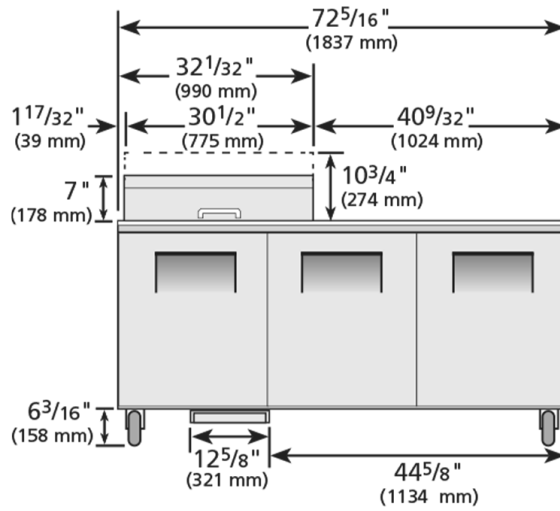

ELEVATION

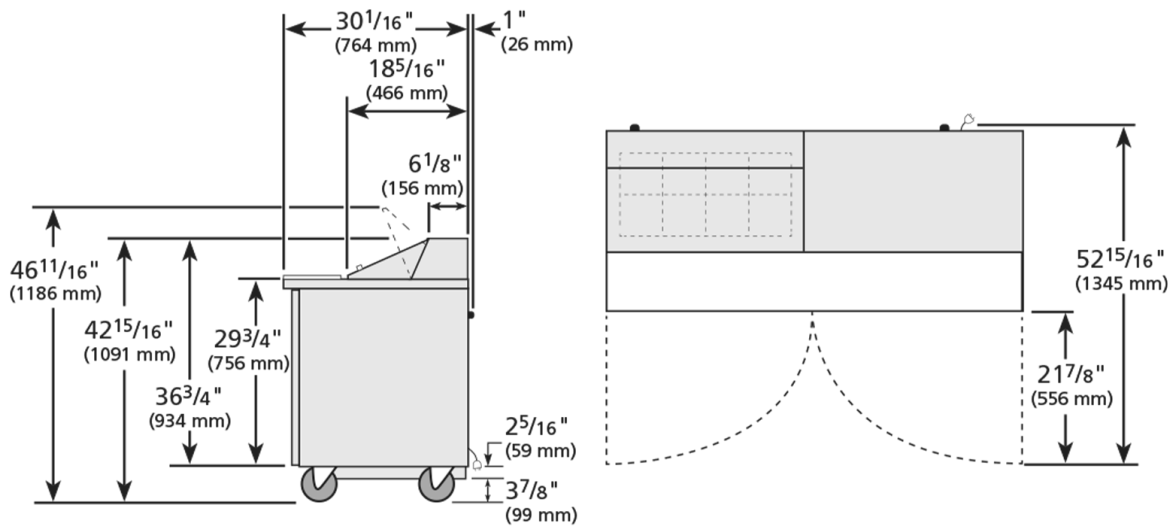

RIGHT VIEW

PLAN VIEW



Specifications subject to change without notice.
 Technical data above related to energy use based on testing of 50Hz or Dual Frequency models
 Chart dimensions rounded up to the next whole millimeter (inches rounded up to the 1/8")

UK & Ireland [0800 783 2049](tel:08007832049)
 EMEA [+41 61 563 07 05](tel:+41615630705)
 Australia [+61 2 9619 9999](tel:+61296199999)

TFIUK@truemfg.com
TrueCHCustomerService@truemfg.com
TrueRefAus@truemfg.com

