

TSSU-36-08-HC

 Prep Table, 8x 1/6 Top Pans, 2 Solid Swing Doors



Dimensions		Build		Technical	
External Width (mm)	924	Door Description	2 Solid Swing Doors	Temperature Holding	0.5 : 5°C
External Depth (mm)	766	Exterior Construction	Stainless steel front, top & hood, aluminium sides and rear	Refrigerant	R290
External Height (mm)	1093	Interior Construction	Clear coated aluminium, stainless steel base	Voltage / Frequency / Phase	220-240V/50-60Hz/1
Exclusions	Depth does not include 26 mm for rear bumpers. Height with lid closed.	Air Intake Position	Front	Amps	1.6
Gross Volume (Litres)	240	Ventilation Position	Front	Wattage	368
Supplied Shelves	4	Clearance Required	Zero back and sides	Defrost Type	Auto
Shelf Size (L x D mm)	Two 395 x 514 + Two 395 x 349	Cord Length (Meters)	3.35		
Internal Net Height (mm)	535	Standard w/ Locks	Not standard (SPEC3 option)		
Top Pans Supplied (max depth mm)	8x 1/6 GN (100)				
Unpackaged Weight (kg)	105				
Packaged Weight (kg)	116				
Packaged Dimensions (W x D x H mm)	991 x 839 x 1270				
Cutting Board (L x D mm)	924 x 299				
Supplied Supports	ø 127 mm castors (158 mm height)				



Specifications subject to change without notice.
 Technical data above related to energy use based on testing of 50Hz or Dual Frequency models
 Chart dimensions rounded up to the next whole millimeter (inches rounded up to the 1/8")

UK & Ireland [0800 783 2049](tel:08007832049)
 EMEA [+41 61 563 07 05](tel:+41615630705)
 Australia [+61 2 9619 9999](tel:+61296199999)

TFIUK@truemfg.com
TrueCHCustomerService@truemfg.com
TrueRefAus@truemfg.com



TSSU-36-08-HC

Prep Table, 8x 1/6 Top Pans, 2 Solid Swing Doors

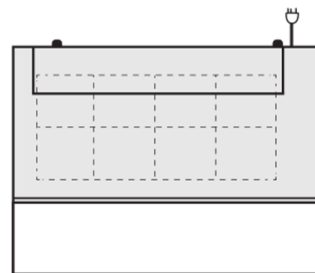
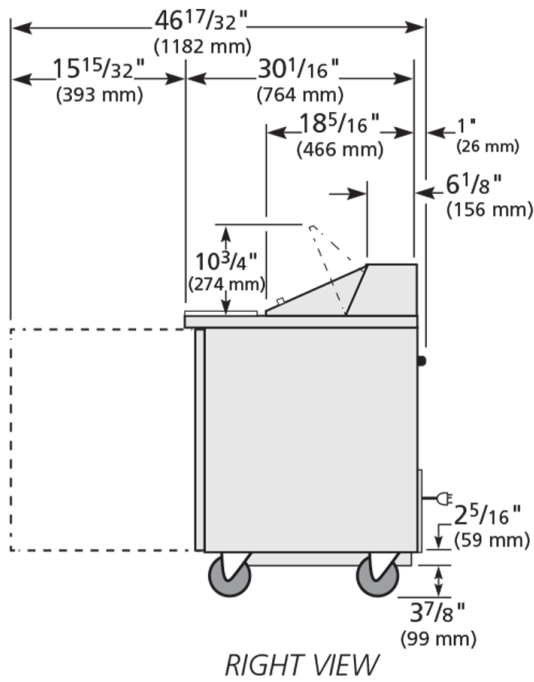
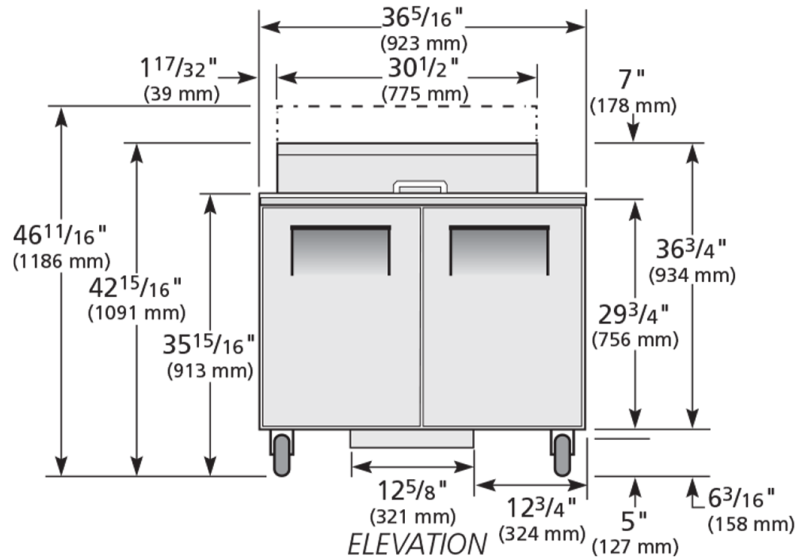

Specifications subject to change without notice.
 Technical data above related to energy use based on testing of 50Hz or Dual Frequency models
 Chart dimensions rounded up to the next whole millimeter (inches rounded up to the 1/8")

UK & Ireland [0800 783 2049](tel:08007832049)
 EMEA [+41 61 563 07 05](tel:+41615630705)
 Australia [+61 2 9619 9999](tel:+61296199999)

TFIUK@truemfg.com
TrueCHCustomerService@truemfg.com
TrueRefAus@truemfg.com

