

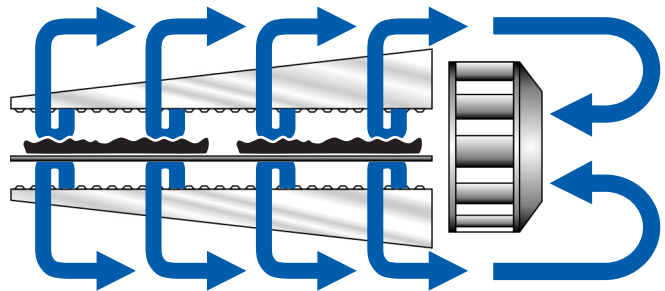

PATENTS PENDING

Principle

Middleby Marshall PS Series conveyor ovens bake both faster and at a lower temperature than other ovens. Patented vertical columns of hot air move heat aerodynamically instead of using high temperatures. The streams of hot air remove the boundary layers of cool heavy air which tend to insulate the product. This gives very rapid baking without burning the product. All PS670 WOW!™ ovens are designed to cook pizza 30% faster than other conveyor ovens.



Standard Features

- **Impingement PLUS!** low oven profile and dual air return
- **Patented EMS energy Management System** reduces gas consumption and increases cooking efficiency
- 70" (1778mm) long cooking chamber
- 32" (813mm) wide, 106" (2692mm) long conveyor belt

Speed

- Advanced technology air delivery system bakes up to 30% faster than standard conveyor ovens

Energy Management System

The PS670 WOW!™ oven features an Energy Management System (EMS) that automatically reduces gas consumption. Touch Screen Control can be programmed in one energy saving mode.

Automatic "energy eye" saves gas when no pizzas are in the oven

Optional Features

Hearth Bake Belt*, for the perfect deck oven crust in a conveyor oven.

Cleanability

PS670 Ovens are designed for easy cleaning. Removable parts include: crumb pans, end panels, air fingers, and a folding conveyor belt assembly.

Easily Services

Control compartment is designed for quick and easy access. All electrical components are door-mounted.

Warranty

All PS670 models have a one year parts and labor warranty. Oven start-up and demonstration are included at no additional charge (USA Only)

Ventilation

For installation under a ventilation hood only.

*Patent Pending

TOP VIEW

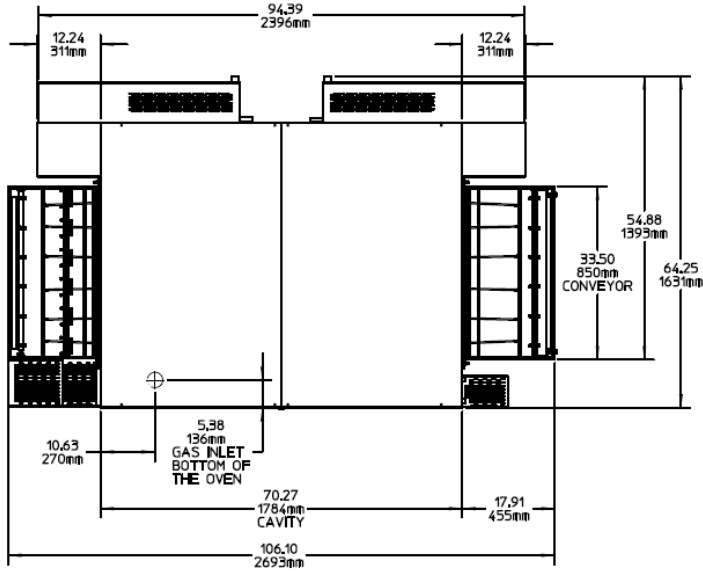

SIDE VIEW

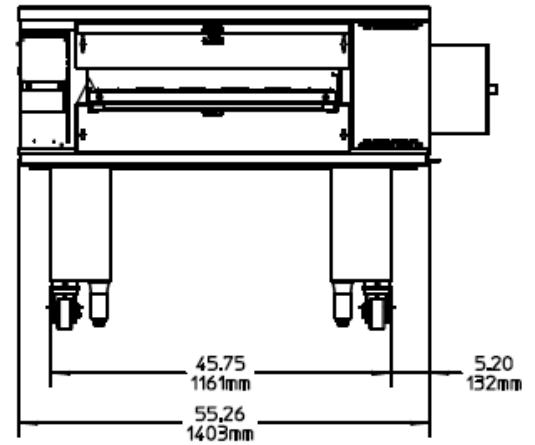

**PS670-1 Single Oven
with 15" (483mm) leg extensions**

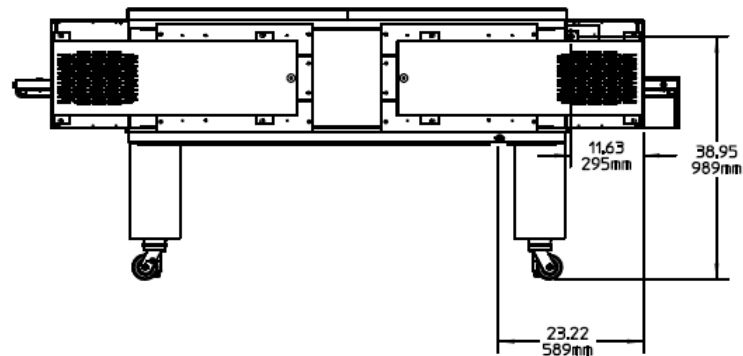
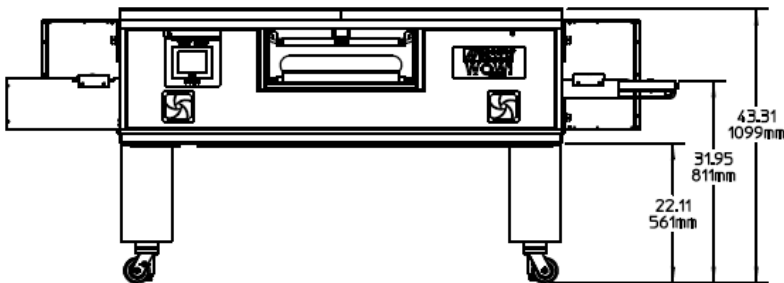

**PS670-2 Double Oven
with 15" (381mm) leg extensions**

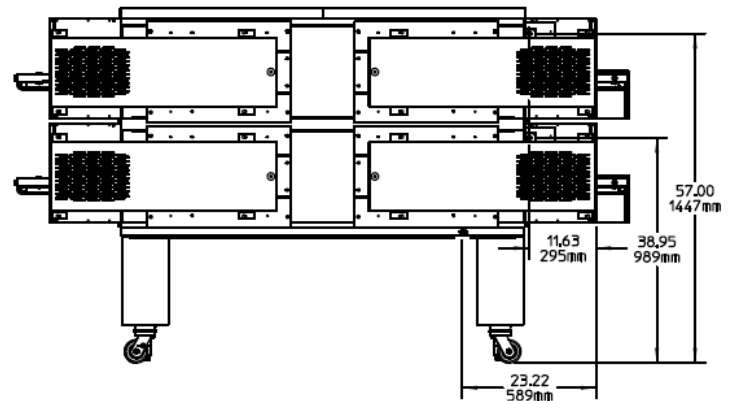
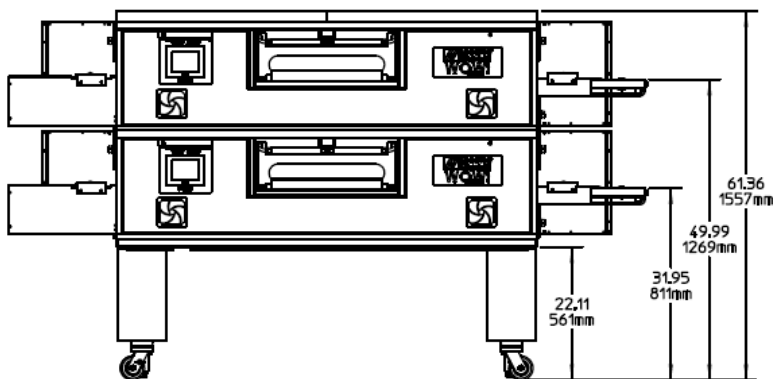

FRONT VIEWS

REAR VIEWS

**PS670-3 Triple Oven
with standard casters**

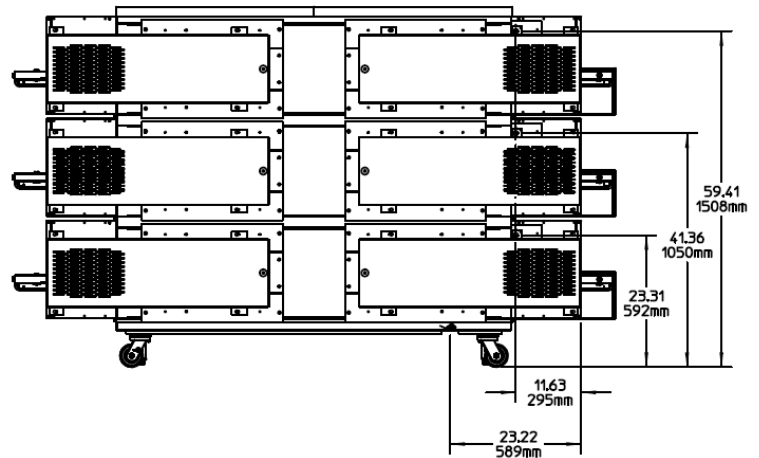
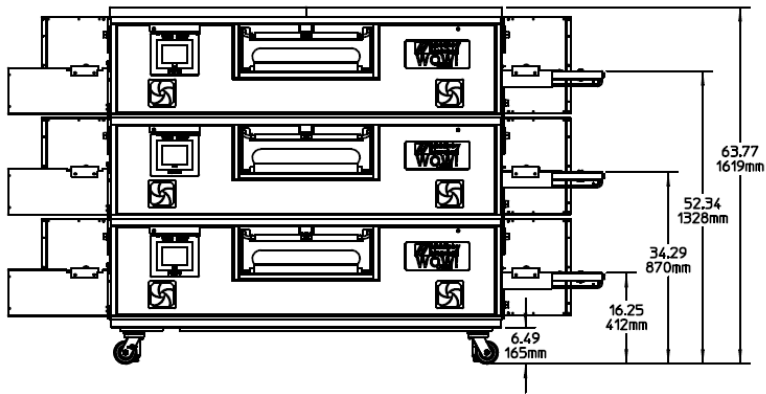

**PS670-3 Triple Oven with
optional Outrigger Base**

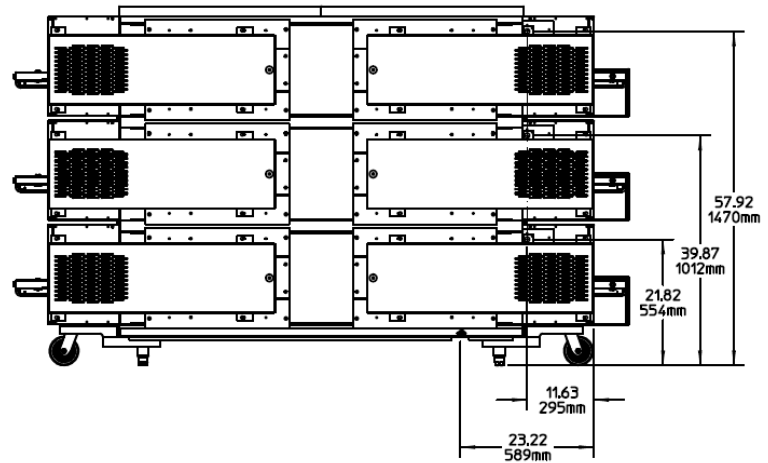
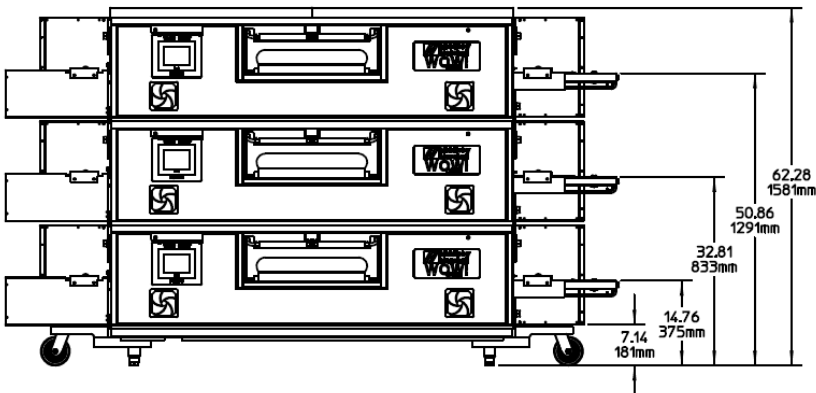

FRONT VIEWS

REAR VIEWS



RECOMMENDED MINIMUM CLEARANCES

Rear of Oven to Wall	Control end of conveyor to wall	Non-control end of conveyor to wall
0" (0mm)	0" (0mm)	0" (0mm)

GENERAL SPECIFICATIONS

	Heating Zone	Baking Area	Belt Length	Belt Width	Depth	Height	Max. Temp	Bake Time Range	Ship Wt	Ship Cube
PS670-1 with 15 70" (483mm) leg extensions	70" 1778mm	15.5sq.ft. 1.44m ²	106" 2690mm	32" 813mm	63" 1599mm	43.31" 11099mm	550°F 288°C	3:00 - 30:00	1750lbs. 795kg	160ft ³ 4.5m ³
PS670-2 with 15" 70" (483mm) leg extensions	140" 3556mm	31sq.ft. 2.88m ²	106" 2690mm	32" 813mm	63" 1599mm	61.36" 1557mm	550°F 288°C	3:00 - 30:00	3500lbs. 1589kg	320ft ³ 9.0m ³
PS670-3 with Standard casters	210" 5334mm	46.5sq.ft. 4.32m ²	106" 2690mm	32" 813mm	63" 1599mm	63.77" 1619mm	550°F 288°C	3:00 - 30:00	5250lbs. 2384kg	480ft ³ 13.5m ³
PS670-3 with Outrigger Base	210" 5334mm	46.5sq.ft. 4.32m ²	106" 2690mm	32" 813mm	63" 1599mm	62.28" 1581mm	550°F 288°C	3:00 - 30:00	5350lbs. 2426kg	480ft ³ 13.5m ³

ELECTRICAL SPECIFICATIONS

Model	Version	Voltage	Phase	Freq	Amps*	Supply	Breakers
PS670	 	208-240v	1	50/60 Hz	20A	2 pole, 3 wire (2 hot, 1 ground)	As per local codes

* The current draw rating shown above are maximum values for normal operation, amperage draw will be less than the listed value.
NOTE: Each oven includes a 6' cord with NEMA# L6-20P plug. Customer to provide NEMA# L6-20R receptacle

GAS SUPPLY SPECIFICATIONS

	Min. Gas Pipe size	Supply Gas Pressure	Rated Heat Input
Natural Gas	2" (50.8mm) main One 1-1/4" (12.7mm NPT branch to lower oven cavity with individual full-flow shutoff valve	6-12" W.C. (14.9-29.8 mbar)	175,000 BTU (44.1 kcal, 51.3 kW/hr) per cavity
Propane Gas	2" (50.8mm) main One 1-1/4" (12.7mm NPT branch to lower oven cavity with individual full-flow shutoff valve	6-12" W.C.. (14.9-29.8 mbar)	175,000 BTU (44.1 kcal, 51.3 kW/hr) per cavity

* The gas supply pressures shown are for ovens installed in North America. The required gas supply pressures of other locations are dependant on the local gas type and on all applicable codes.
Each oven comes with (1) 1-1/4" NPT x 48" flexible vinyl coated gas hose.

ALL SPECIFICATIONS SUBJECT TO CHANGE WITHOUT NOTICE.