

Tilting jacketed kettle with mixer indirect electric heating



POTAGES
 PUDDING
 PASTA AND RICE
 SAUCES
 MASHED POTATOES
 BECHAMEL SAUCE
 PUREE
 JELLY

TILTING KETTLES FOR LARGE CATERING AND RESTAURANTS

EASYBRATT is a tilting braising pan designed to meet the daily needs of small and medium-sized restaurants, the catering industry and centralised cooking facilities (canteens, community centres, schools, hospitals, etc.). Composed of 38 models with different capacities, this machine for catering is available in gas or electric heating from 50 to 200 litres. The tilting is manually-operated, but can be motorised on request.

ANY TYPE OF COOKING IN PERFECT HARMONY, A NEW BENCHMARK THANKS TO BASKETT

Heating is gentle, indirect, thereby allowing you to prepare more delicate dishes and they do not need constant monitoring. An asset in the kitchen that lets you utilise your experience to satisfy high volumes. Efficient, compact and versatile.

Heating type	indirect electric
Capacity (L)	301
Surface (dmq)	-
Gas connection (Ø)	-
Electric connection (V/-/Hz)	3N+PE AC 400V 50/60 Hz

Width (mm)	1655
Depth (mm)	1490
Height (mm)	1285
Gas power (Mj/hr)	-
Electric power (kW)	37.5

boiling | braising | pasteurising | **tilting** | **mixing** | **cooling** | frying | underpressure | vacuum cooking | cutting | washing | drying

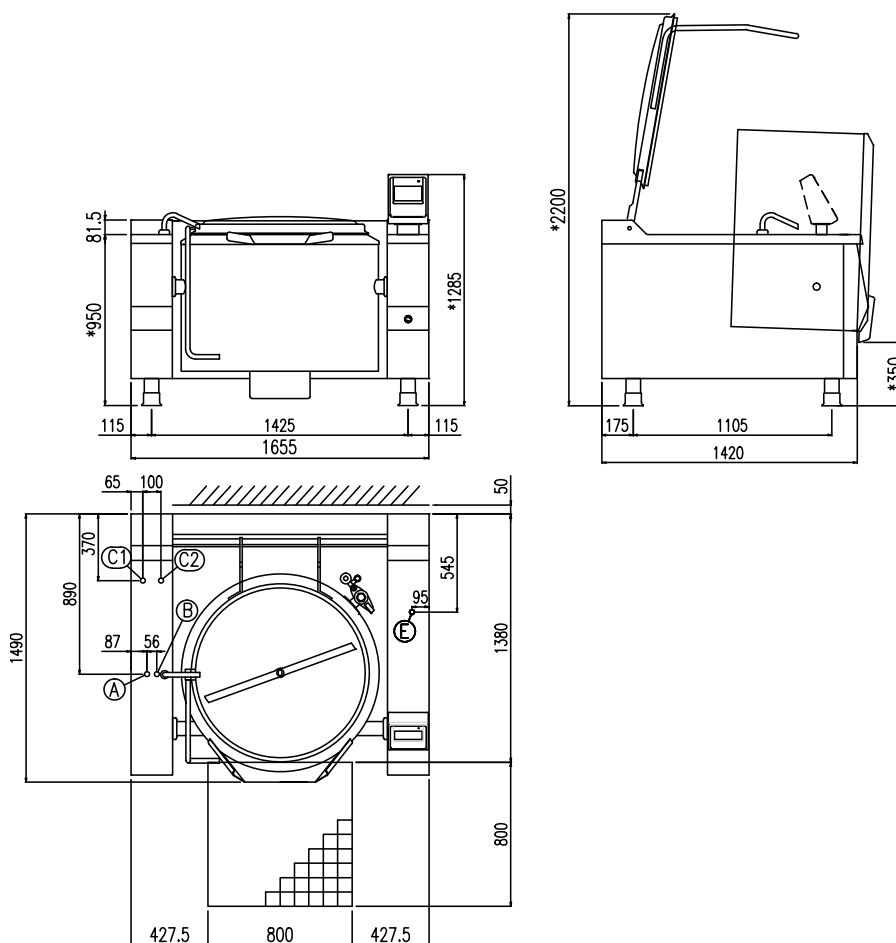

E	Potenza assorbita Electric power	Elektrische Leistung Puissance Électrique	37.50 (kW)
E	Collegamento Elettrico Electric connection	Elektrische Verbindung Connexion Électrique	380-415V 3N ~ 50/60Hz
A	Allacciamento Acqua Calda Hot water inlet	Warmwasseranschluss Raccordement eau chaude	3/4"
B	Allacciamento Acqua Fredda Cold water inlet	Kaltwasseranschluss Raccordement eau froide	3/4"

boiling | braising | pasteurising | **tilting** | **mixing** | **cooling** | frying | underpressure | vacuum cooking | cutting | washing | drying