

Tilting boiling pan indirect gas heating



THICK SOUPS
 THIN SOUPS
 BOILED FOODS
 BROTHS
 CUSTARDS
 PUDDINGS
 DAIRY BASED PRODUCTS

PROFESSIONAL CATERING EQUIPMENT

EASYBASKETT is a functional boiling cooking machine that is easy to use, ideal for cooking large quantities of food, even foods with high acidity. In the indirect versions, the jacket system prevents products from sticking to the bottom and walls of the container during cooking.

THE POTENTIAL OF FIREX TILTING KETTLES

The main construction features of these machines for professional catering and, especially, the use of quality materials guarantee high performance and maximum versatility. With this type of tilting kettles you can cook even large amounts of food without the products sticking to the bottom or walls.

Heating type	indirect gas
Capacity (L)	100
Surface (dmq)	-
Gas connection (Ø)	1/2"
Electric connection (V/-/Hz)	1N+PE AC 230V 50/60 Hz

Width (mm)	1445
Depth (mm)	1180
Height (mm)	1090
Gas power (Mj/hr)	75.6
Electric power (kW)	0.2

boiling | braising | pasteurising | **tilting** | mixing | cooling | frying | underpressure | vacuum cooking | cutting | washing | drying

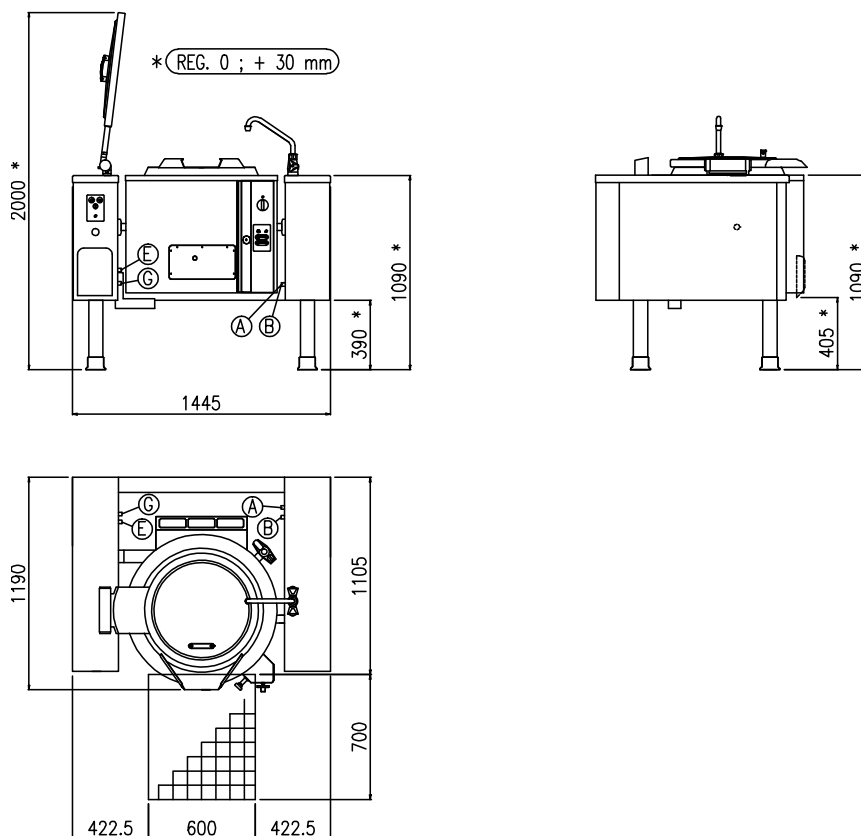

G	Attacco Gas (secondo ISO 7-1) Gas Connection (ISO 7-1)	Gasanschluss (ISO 7-1) Raccordement Gaz (ISO 7-1)	1/2"
E	Potenza assorbita Electric power	Elektrische Leistung Puissance Électrique	.20 (kW)
E	Collegamento Elettrico Electric connection	Elektrische Verbindung Connexion Électrique	220-240V 1N ~ 50/60Hz
A	Allacciamento Acqua Calda Hot water inlet	Warmwasseranschluss Raccordement eau chaude	3/4"
B	Allacciamento Acqua Fredda Cold water inlet	Kaltwasseranschluss Raccordement eau froide	3/4"

boiling | braising | pasteurising | **tilting** | mixing | cooling | frying | underpressure | vacuum cooking | cutting | washing | drying