

Stationary pressurised boiling pan indirect electric heating



SOUPS
 PASTA
 RICE
 SAUCES
 BOILED FOODS
 BROTHS
 DAIRY BASED PRODUCTS
 COFFEE
 TEA
 BOILED VEGETABLES
 PASTEURISATION OF JARS

FIXPAN: THE EFFICIENT PASTEURISER

The Fixpan pasteurizers are available in 48 different models (with gas, electrical or steam heating) and are the simplest and most immediate resource for cooking large quantities of food in water. With capacities from 100 to 550 litres, electronic control and autoclave pressure lid, these fixed industrial pans carry out with industrial precision and efficiency all the functions, including the possibility to perform the pasteurisation process on a product that is already packaged (e.g. jars).

INDUSTRIAL PANS FOR PASTEURISATION OF JARS AND FOODS

Ideal for cooking in water and pasteurising food and jars, thanks to the optional “Cook & Chill” system you can carry out the cooking and cooling of the product inside the tank. All the pasteurisers, in the different available models, can be equipped with a “sample probe” that allows you to check the temperature at the core of the product. Thanks to its cylindrical shape, finally, cleaning operations are fast and effective.

Heating type	indirect electric
Capacity (L)	325
Surface (dmq)	-
Gas connection (Ø)	-
Electric connection (V/-/Hz)	3N+PE AC 400V 50/60 Hz

Width (mm)	1340
Depth (mm)	1130
Height (mm)	900
Gas power (Mj/hr)	-
Electric power (kW)	36

[boiling](#) | [braising](#) | [pasteurising](#) | [tilting](#) | [mixing](#) | [cooling](#) | [frying](#) | [underpressure](#) | [vacuum cooking](#) | [cutting](#) | [washing](#) | [drying](#)

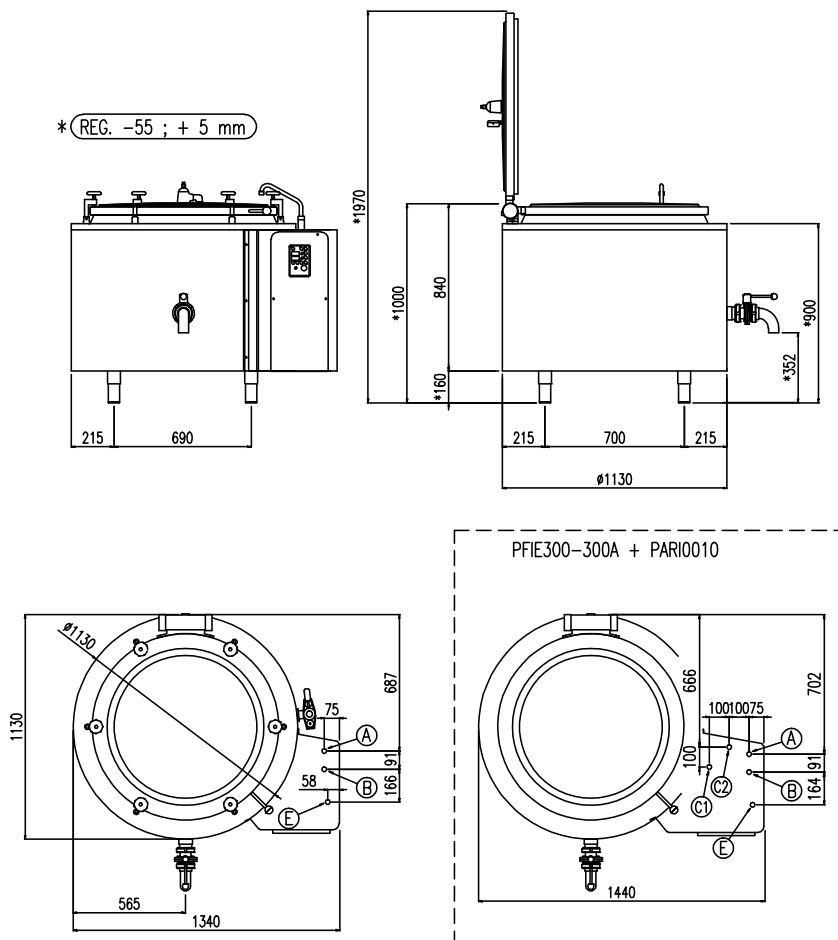

E	Potenza assorbita Electric power	Elektrische Leistung Puissance Électrique	36.00 (kW)
E	Collegamento Elettrico Electric connection	Elektrische Verbindung Connexion Électrique	380-415V 3N ~ 50/60Hz
A	Allacciamento Acqua Calda Hot water inlet	Warmwasseranschluss Raccordement eau chaude	1/2"
B	Allacciamento Acqua Fredda Cold water inlet	Kaltwasseranschluss Raccordement eau froide	1/2"

boiling | braising | **pasteurising** | tilting | mixing | cooling | frying | **underpressure** | vacuum cooking | cutting | washing | drying