

Stationary boiling pan direct gas heating



FIXPAN: THE EFFICIENT PASTEURISER

The Fixpan pasteurizers are available in 48 different models (with gas, electrical or steam heating) and are the simplest and most immediate resource for cooking large quantities of food in water. With capacities from 100 to 550 litres, electronic control and autoclave pressure lid, these fixed industrial pans carry out with industrial precision and efficiency all the functions, including the possibility to perform the pasteurisation process on a product that is already packaged (e.g. jars).

INDUSTRIAL PANS FOR PASTEURISATION OF JARS AND FOODS

Ideal for cooking in water and pasteurising food and jars, thanks to the optional "Cook & Chill" system you can carry out the cooking and cooling of the product inside the tank. All the pasteurisers, in the different available models, can be equipped with a "sample probe" that allows you to check the temperature at the core of the product. Thanks to its cylindrical shape, finally, cleaning operations are fast and effective.

SOUPS
PASTA
RICE
SAUCES
BOILED FOODS
BROTHS
DAIRY BASED PRODUCTS
COFFEE
TEA
BOILED VEGETABLES
PASTEURISATION OF JARS

Heating type	direct gas
Capacity (L)	362
Surface (dmq)	-
Gas connection (Ø)	3/4"
Electric connection (V/-/Hz)	1N+PE AC 230V 50Hz

Width (mm)	1340
Depth (mm)	1255
Height (mm)	900
Gas power (Mj/hr)	172.8
Electric power (kW)	0.2

boiling | braising | **pasteurising** | tilting | mixing | cooling | frying | underpressure | vacuum cooking | cutting | washing | drying

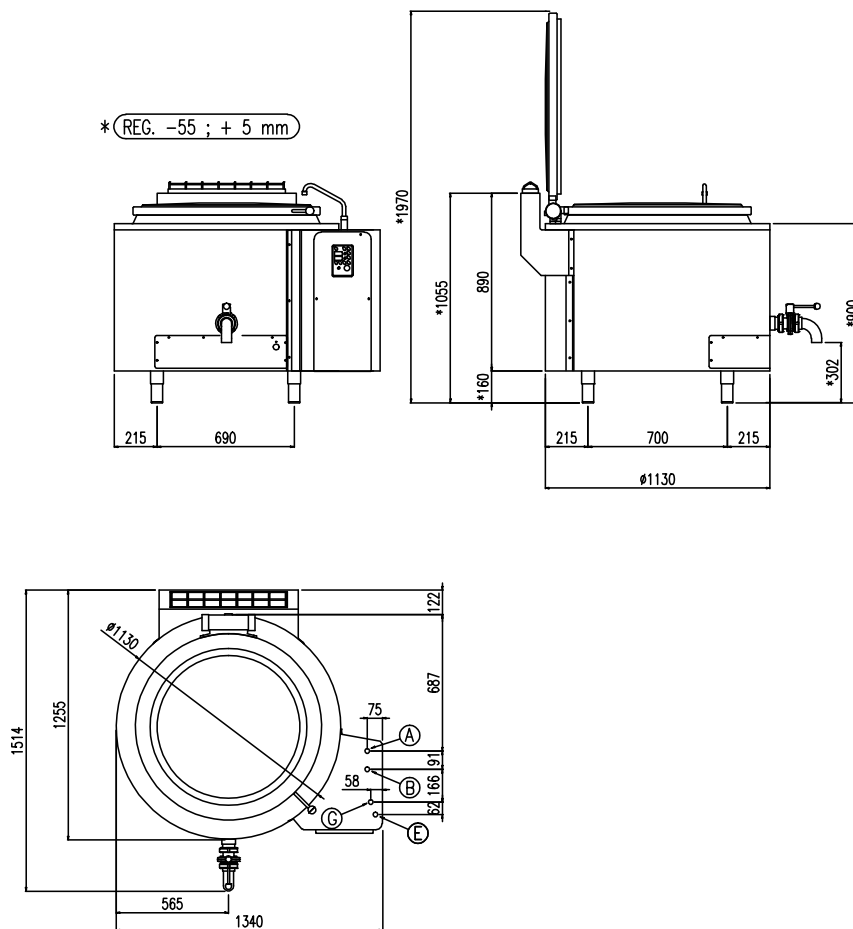

G	Attacco Gas (secondo ISO 7-1) Gas Connection (ISO 7-1)	Gasanschluss (ISO 7-1) Raccordement Gaz (ISO 7-1)	3/4"
E	Potenza assorbita Electric power	Elektrische Leistung Puissance Électrique	.20 (kW)
E	Collegamento Elettrico Electric connection	Elektrische Verbindung Connexion Électrique	220-240V 1N ~ 50Hz
A	Allacciamento Acqua Calda Hot water inlet	Warmwasseranschluss Raccordement eau chaude	1/2"
B	Allacciamento Acqua Fredda Cold water inlet	Kaltwasseranschluss Raccordement eau froide	1/2"

boiling | braising | **pasteurising** | tilting | mixing | cooling | frying | underpressure | vacuum cooking | cutting | washing | drying