



HSW013E

Hot holding cabinet
with drawers

CONSTRUCTION FEATURES

- Tightness chamber with radiused corners
- Drawer's guides AISI 304 18/10 stainless steel
- Total thermic insulation with rock or glass wool
- Long lasting drawers seals made up of food grade of high heat resistance
- Static heating provided by low consumption wire heating element that coils up all the chamber
- Handles to carry by hand
- Ergonomic and fully built-in drawers handle with magnetic closure

FUNCTIONAL FEATURES

- Electronic control of the temperature
- Operating temperature 30° ÷ 120°C
- Two humidity vents: on the drawer and rear wall
- Designed for stacking
- Chamber with safety thermostat

STANDARD SUPPLY

- Removable GN1/1 tray racks

MODULINESRL



moduline

**TECHNICAL
INSTALLATION
DIAGRAM**

Electricity supply
cable inlet 

Adjustable vent
for release of
excess humidity 

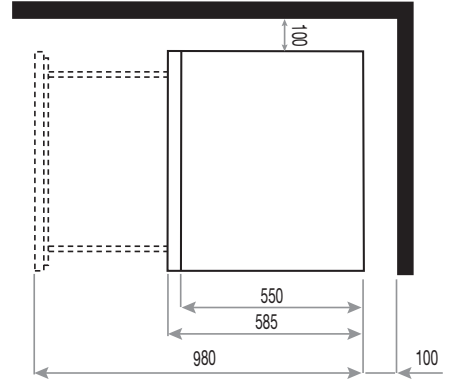
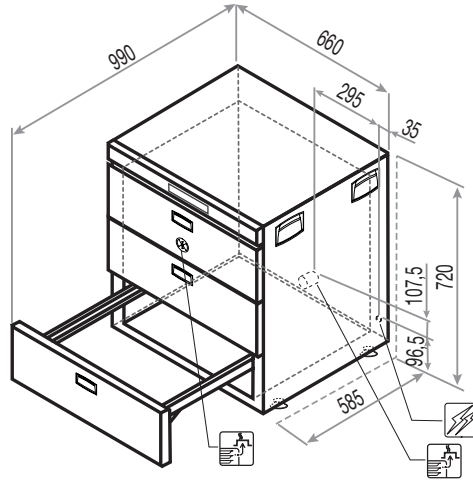

Overall dimensions (W x D x H) - mm	660 x 585 x 720h	Working temperature [°C]	30÷120
Trays capacity	3 GN 1/1 (150h)	Containers capacity distance [mm]	3 GN 1/1 (70)
Power kW	1	Containers max height [mm]	150 (h)
Power supply	AC 230V 50 Hz	Product max capacity [kg]	18
Rated voltage [Vac]	230	Net weight	67
Total input [Kw]	1		
Amps. [A]	4,4		
Connecting wire min. section (type H07 RN-F) [mm²]	3 x 1		

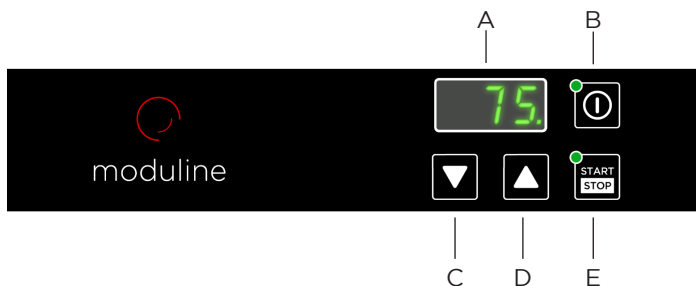

- A Display
- B ON/OFF switch
- C Temperature decrease key
- D Temperature increase key
- E START/STOP key

MODULINESRL

Via dell'Industria 11, Z.I. San Giacomo di Veglia 31029 Vittorio Veneto (TV) - ITALY
tel. +39 0438 5063 - fax +39 0438 912 323 - info@moduline.it - www.moduline.it