



PRODUCT ADVANTAGES

- Uniformness of the cooking process:
 - Oscillating fan
 - Permeable separating grid between fan and cavity (for table models)
 - With efficient ventilator
- Speed of the cooking process:
 - Efficient and fast steam production due to latest injection technology
 - Fast temperature transition due to an open grid
 - Rapid cooling of the cavity due to cool-down function
- Efficient fully automatic cleaning system:
 - Fully automatic, economic and fast
 - Low water consumption due to closed cycle
 - Programmes:
 - Level 1: 30 minutes
 - Level 2: 33 minutes
 - Level 3: 39 minutes
 - Optional drying: 4 minutes
 - Rinsing: 2 minutes
- Crosswise loading enables an easy handling, a better overview and more safety
- FastPAD: Touch control panel, clear, intuitive and ergonomic, graphical display with text and photos
- AirControl: Continuous adjustment and oscillating fan
- JetControl: Latest injection technology and rapid cooling of the cavity
- CoreControl: Appropriate energy supply according to demand, set and actual display
- TwinControl: Patented system doubling the essential oven functions
- SUPPLIED WATER TREATMENT SYSTEM MUST BE INSTALLED ON THE INCOMING WATER SUPPLY FEEDING THE COMBI OVEN

TECHNICAL DATA

Flow pressure	1.5 - 6 bar
Recommended water hardness	3 - 4.5 °dH
Total loading Electro Standard	9.3 kW 14.3 A
Noise level	< 70 dB (A)

CONNECTIONS

① Fresh-water connection	2x G 3/4"
② Drain connection	G 1 1/2"
③ Power connection Electro	400 / 50 / 3 / N / PE (M32)
④ Suction hose for detergent	2000 mm
⑤ Connection for potential compensation	M5
⑥ Ventilation	35 mm
⑦ Vapour extractor	70 mm

DIMENSIONAL DRAWING

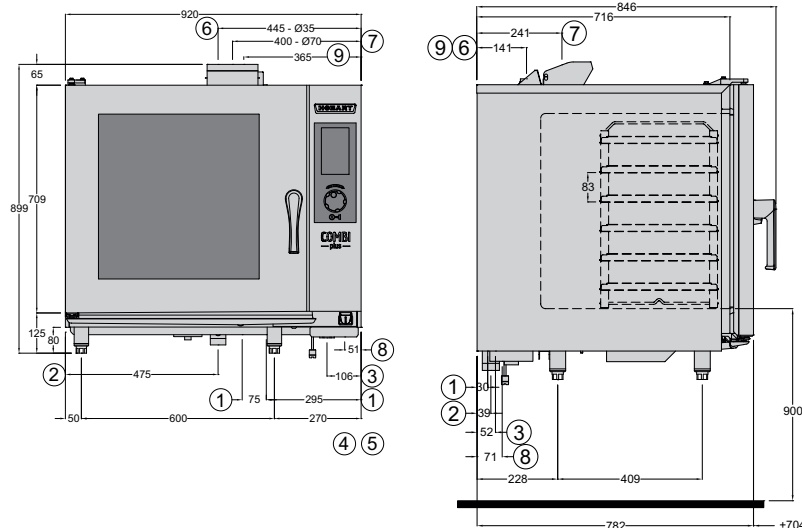

* ⑧/⑨ only for gas models