

Large tilting braising pan with mixer direct steam heating



STEWES
GOULASH
SAUCES
VEGETABLES
ONIONS
PASTA STUFFINGS

EQUIPMENT FOR PROFESSIONAL KITCHENS

Safety, reliability, better quality of the finished product, greater availability of human resources, savings in time and money can be summed up in one word: CUCIMIX. It is a gas or electric tilting bratt pan with direct heating and built-in mixer, designed for large catering services and the food industry.

THE BEST IN TILTING BRAISING PANS

This multifunctional cooker is complete, innovative and sturdy, ideal for countless applications, from sauces to jams and marmalades, from meat to steamed vegetables. Among the equipment for professional kitchens, Cucimix is really one of the most versatile and evolved, since it allows different types of preset cooking: steaming, boiling, pressure cooking, braising and browning.

Heating type	direct steam
Capacity (L)	90
Surface (dmq)	-
Gas connection (Ø)	-
Electric connection (V/-/Hz)	1N+PE AC 230V 50Hz

Width (mm)	1445
Depth (mm)	1290
Height (mm)	1285
Gas power (Mj/hr)	-
Electric power (kW)	0.6

boiling | **braising** | pasteurising | **tilting** | **mixing** | cooling | frying | underpressure | vacuum cooking | cutting | washing | drying

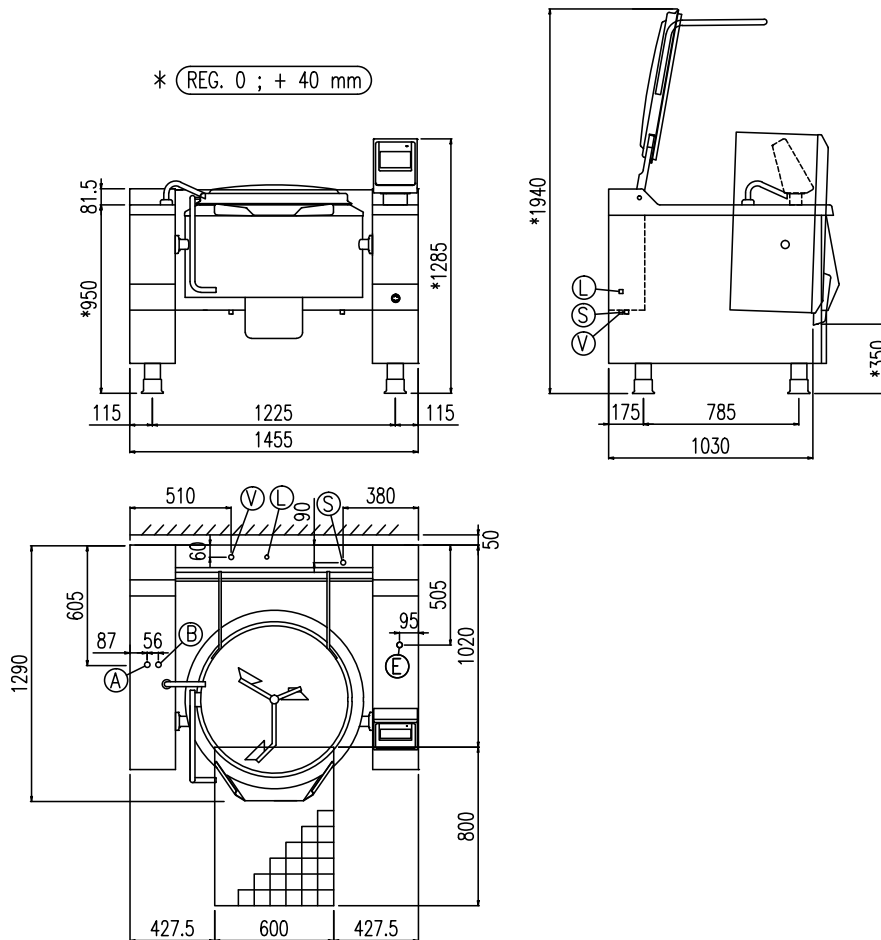

E	Potenza assorbita Electric power	Elektrische Leistung Puissance Électrique	.60 (kW)
E	Collegamento Elettrico Electric connection	Elektrische Verbindung Connexion Électrique	220-240V 1N ~ 50Hz
V	Allacciamneto Vapore Steam connection	Dampfanschluss Connexion vapeur	3/4"
S	Scarico Condensa Condensate drain	Kondenswasserablauf Sortie du condenseur	3/4"
A	Allacciamento Acqua Calda Hot water inlet	Warmwasseranschluss Raccordement eau chaude	3/4"
B	Allacciamento Acqua Fredda Cold water inlet	Katlwasseranschluss Raccordement eau froide	3/4"

boiling | braising | pasteurising | tilting | mixing | cooling | frying | underpressure | vacuum cooking | cutting | washing | drying