



B+S BLACK SERIES: CBR-6

Char Broiler 600mm

Project: _____ Item: _____



CBR-6

Standard Features:

- AISI 304 grade stainless steel
- Heavy duty cast iron cooking J grates and radiant hoods
- Piezo ignition and flame failure device
- Multi-setting gas valve as standard allowing for greater regulation of flame setting
- Open stand with under shelf
- Easy to clean fat spillage tray
- Front access to all components makes service easy
- Heavy duty stainless steel frame construction
- 18-month warranty

Options:

- Natural or LP gas

Specifications:

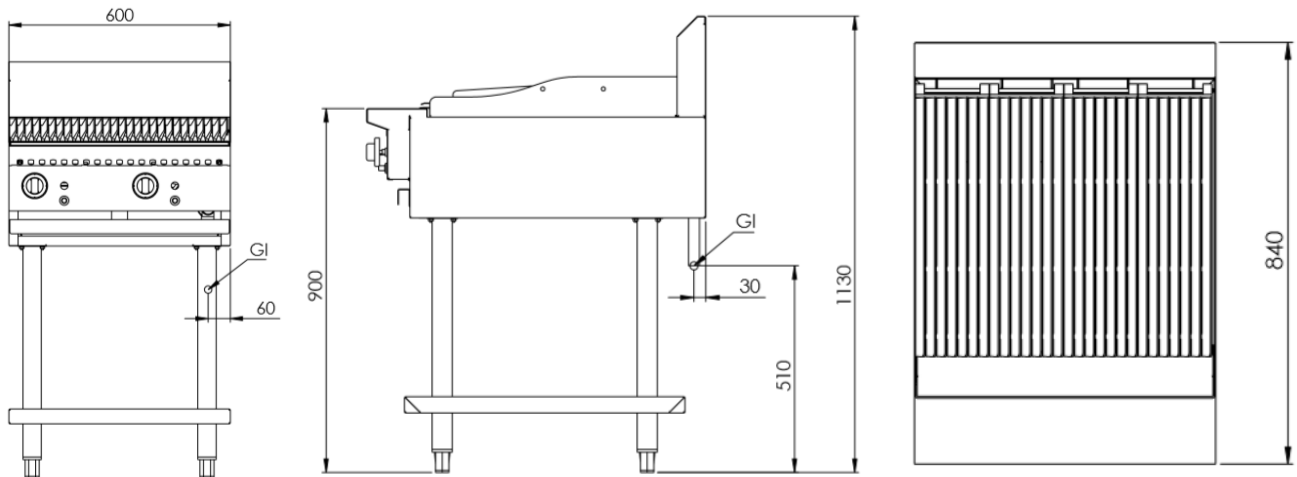

MODEL	LENGTH (mm)	DEPTH (mm)	HEIGHT (mm)	GAS CONSUMPTION (Mj/h)	
				NG	LPG
CBR-6	600	840	1130	66	60

Connections:

GAS (GI) (BSP)	SUPPLY PRESSURE (kPa)	
	NG	LPG
3/4" (M)	1.0	2.6

- Regulator is included in the unit
- **Must** be installed by an authorised installer

Due to ongoing Product Development, Product Improvement and Research, B+S Commercial Kitchens reserves the right to alter specification without notice.



B+S Commercial Kitchens
 57 Plateau Road Reservoir VIC 3073 Australia | +61 3 9469 4754
 info@bscommercialkitchens.com | www.bscommercialkitchens.com

