

Tilting boiling pan indirect electric heating



THICK SOUPS
THIN SOUPS
BOILED FOODS
BROTHS
CUSTARDS
PUDDINGS
DAIRY BASED PRODUCTS

PROFESSIONAL CATERING EQUIPMENT

EASYBASKETT is a functional boiling cooking machine that is easy to use, ideal for cooking large quantities of food, even foods with high acidity. In the indirect versions, the jacket system prevents products from sticking to the bottom and walls of the container during cooking.

THE POTENTIAL OF FIREX TILTING KETTLES

The main construction features of these machines for professional catering and, especially, the use of quality materials guarantee high performance and maximum versatility. With this type of tilting kettles you can cook even large amounts of food without the products sticking to the bottom or walls.

Heating type	indirect electric
Capacity (L)	100
Surface (dmq)	-
Gas connection (Ø)	-
Electric connection (V/-/Hz)	3N+PE AC 400V 50/60 Hz

Width (mm)	1200
Depth (mm)	1085
Height (mm)	900
Gas power (Mj/hr)	-
Electric power (kW)	16

boiling | braising | pasteurising | **tilting** | mixing | cooling | frying | underpressure | vacuum cooking | cutting | washing | drying

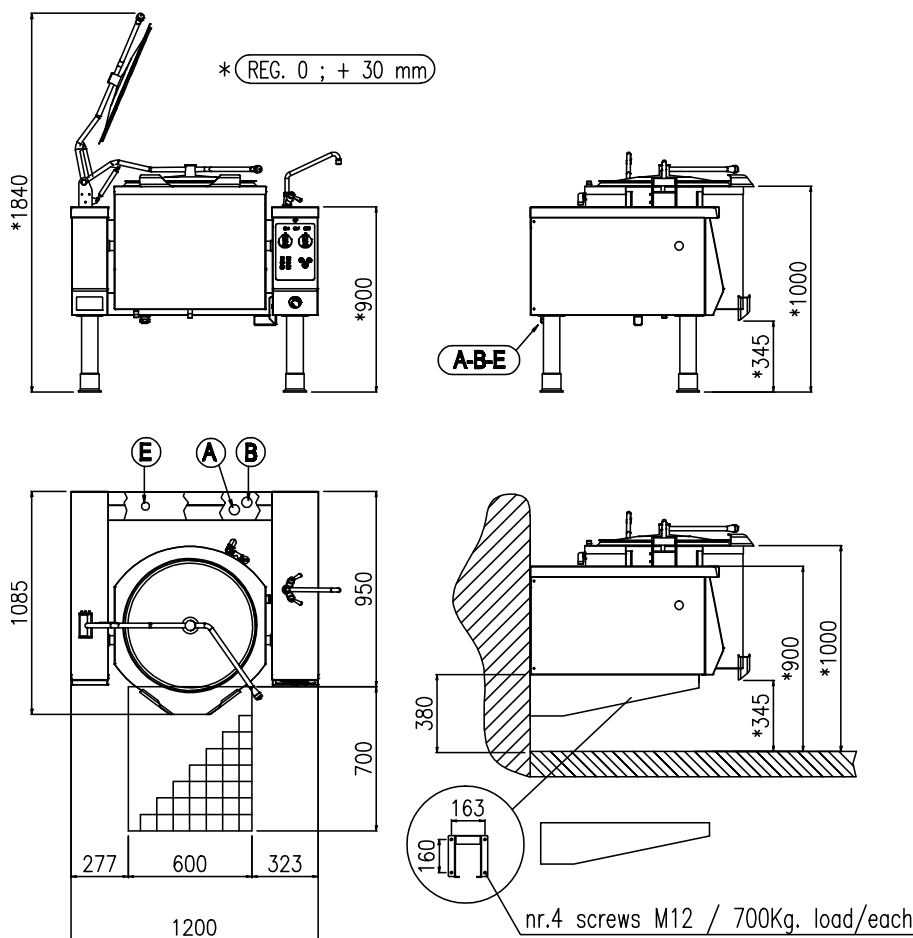

E	Potenza assorbita Electric power	Elektrische Leistung Puissance Électrique	16.00 (kW)
E	Collegamento Elettrico Electric connection	Elektrische Verbindung Connexion Électrique	380-415V 3 ~ 50/60Hz
A	Allacciamento Acqua Calda Hot water inlet	Warmwasseranschluss Raccordement eau chaude	3/4"
B	Allacciamento Acqua Fredda Cold water inlet	Kaltwasseranschluss Raccordement eau froide	3/4"

boiling | braising | pasteurising | **tilting** | mixing | cooling | frying | underpressure | vacuum cooking | cutting | washing | drying