

Fixed square body boiling pan with autoclave direct gas heating



BROTHS
RICE
PASTA
THICK SOUPS
THIN SOUPS
POTATO OR VEGETABLE
PUREES
BECHAMEL SAUCE

MODULAR PANS FOR RESTAURANTS AND CATERING SERVICES

The EASYPAN boiling pan is the extremely modular and professional solution developed by Firex to meet the needs of small restaurants and catering services to treat particularly acid products, thanks to the use of AISI 316 stainless steel.

THE ADVANTAGES OF COOKING FOOD IN WATER

This type of modular industrial pans, whether cylindrical or rectangular, is characterised by a high quality of materials and construction processes; all to ensure maximum safety and reliability over time.

Heating type	direct gas
Capacity (L)	230
Surface (dmq)	-
Gas connection (Ø)	1/2"
Electric connection (V/-/Hz)	-

Width (mm)	1000
Depth (mm)	1150
Height (mm)	900
Gas power (Mj/hr)	124.2
Electric power (kW)	-

boiling | braising | pasteurising | tilting | mixing | cooling | frying | underpressure | vacuum cooking | cutting | washing | drying

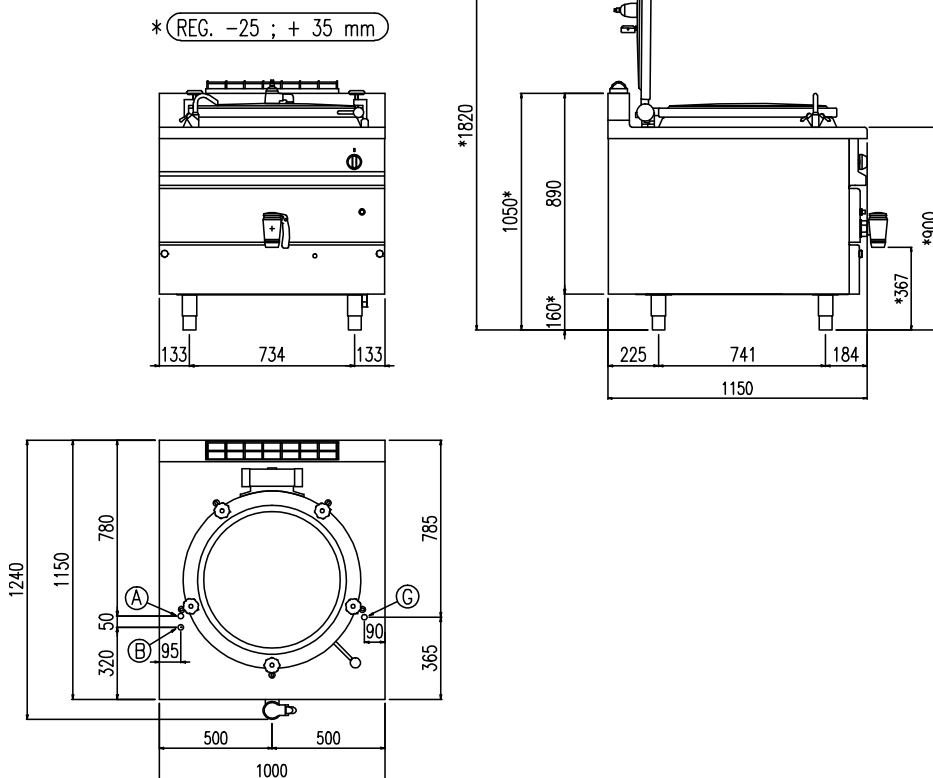

G	Attacco Gas (secondo ISO 7-1) Gas Connection (ISO 7-1)	Gasanschluss (ISO 7-1) Raccordement Gaz (ISO 7-1)	1/2"
A	Allacciamento Acqua Calda Hot water inlet	Warmwasseranschluss Raccordement eau chaude	1/2"
B	Allacciamento Acqua Fredda Cold water inlet	Kaltwasseranschluss Raccordement eau froide	1/2"

boiling | braising | pasteurising | tilting | mixing | cooling | frying | underpressure | vacuum cooking | cutting | washing | drying