



# VERRO SERIES: VBT-GRP6-CBR3

## Combination 600mm Grill Plate & 300mm Char Broiler

Project: \_\_\_\_\_ Item: \_\_\_\_\_



VBT-GRP6-CBR3

### Standard Features:

- AISI 304 grade stainless steel
- Heavy duty complete stainless-steel cabinet frame
- Removable pressed top spillage tray for easy cleaning
- Multi-setting gas valve as standard allowing for greater regulation of flame setting
- Pilot take off fitted as standard
- Heavy duty mild steel plate (GRP section)
- Heavy duty cast iron cooking J grates and radiant hoods (CBR section)
- Easy access to all components for servicing and adjustment
- 24 Month warranty
- Flame Failure

### Options:

- Castors
- Plinth Mounted
- Natural or LP gas

### Specifications:

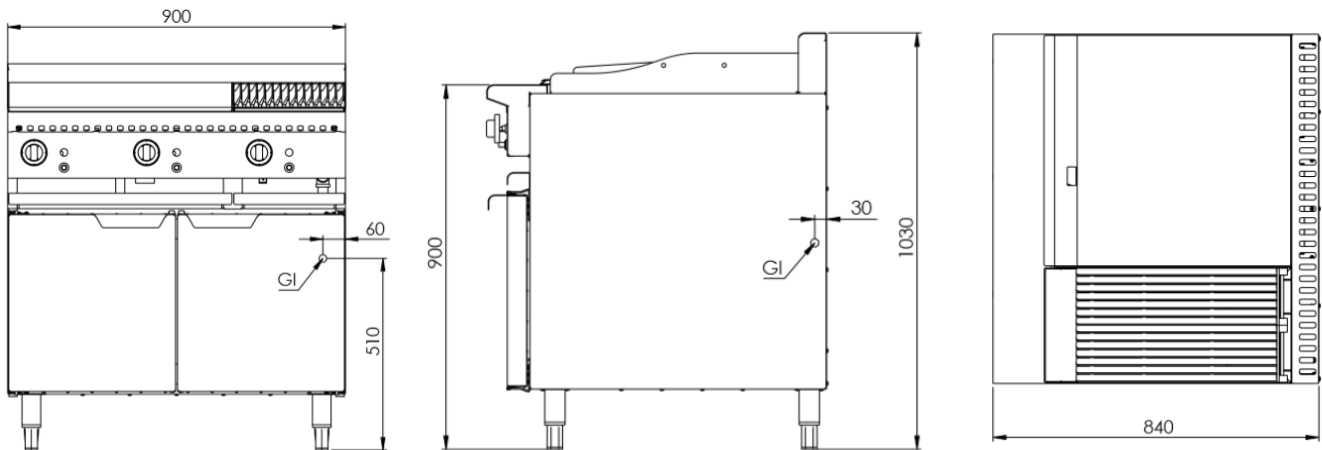

MODEL	LENGTH (mm)	DEPTH (mm)	HEIGHT (mm)	GAS CONSUMPTION (Mj/h)	
				NG	LPG
VBT-GRP6-CBR3	900	840	1030	77	74

### Connections:

GAS (GI) (BSP)	SUPPLY PRESSURE (kPa)	
	NG	LPG
3/4" (M)	1.0	2.6

- Regulator is included in the unit
- **Must** be installed by an authorised installer

**Due to ongoing Product Development, Product Improvement and Research, B+S Commercial Kitchens reserves the right to alter specification without notice.**



B+S Commercial Kitchens  
 57 Plateau Road Reservoir VIC 3073 Australia | +61 3 9469 4754  
 info@bscommercialkitchens.com | www.bscommercialkitchens.com

